



# PSC quick-change tool holders BMT 60

**MTRent**

Mtcut T25/32 Y/SY



## Turning made better

PSC turning tool holders are go-to solution for maximizing process efficiency.

Used in both standard turn centers and hybrid mill-turn machines, PSC turning tool holders enable fast tool change solution for reduced down-time and increased productivity without compromise on stability and rigidity. Additionally, direct high pressure coolant nozzles increase tool life with higher feeds and speeds

More time making chips and less time in unwanted stops makes investment in Polygonal taper tool holders a great choice with a fast return.

### Key benefits of PSC turning tools:

- Reduced setup and tool change time - maximum utilisation of the machine
- Increased stability and versatility - in vertical lathes, multi-tasking machining centers and machining centers with turning possibilities
- Ultimate repeatability - allowing offline tool presetting
- Reduced tool inventory and storage space in workshop - due to universal interface for both turning and milling
- Self centering system provides high precision and repeatability
- Carbide shims to prevent insert seats from damage
- Quick change, monobloc system without additional interfaces

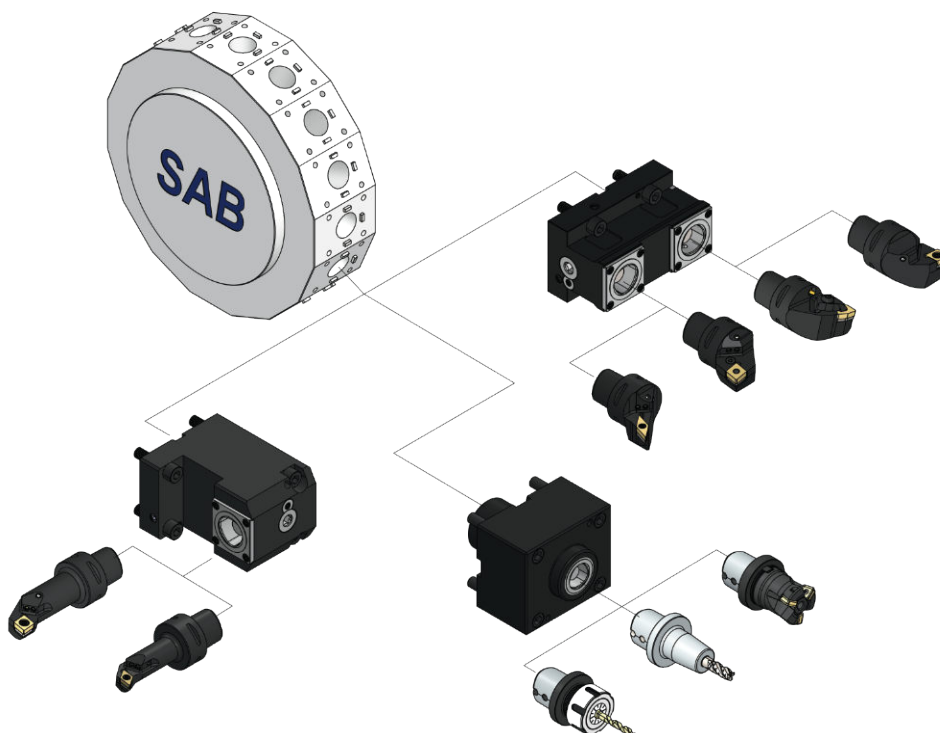

## OD single holder

Right or left single OD quick coupling C4 holder

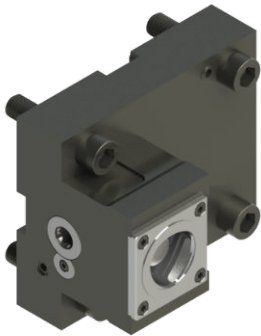

Turret  
BMT60

Code  
C4.DVR/L.MS60A

## OD double holder

Right or left double OD quick coupling C4 holder

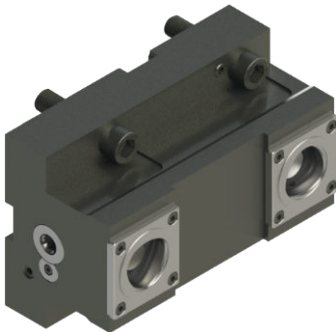

Turret  
BMT60

Code  
C4.DVR/L.MS60A.D

## OD Y holder

Right or left Y-axis OD quick coupling C4 holder

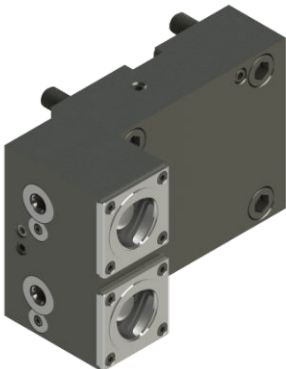

Turret  
BMT60

Code  
C4.DVR/L.MS60A.Y

## OD double Y holder

Right or left double Y-axis OD quick coupling C4 holder



Turret  
BMT60

Code  
C4.DVR/L.MS60A.DY

## ID single holder

Right or left single ID quick coupling C4 holder

Turret	Code
BMT60	C4.DUR/L.MS60A

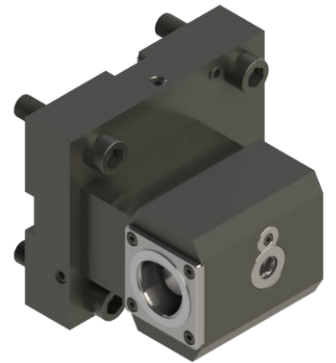

## ID double holder

Right or left double ID quick coupling C4 holder

Turret	Code
BMT60	C4.DUR/L.MS60A.D

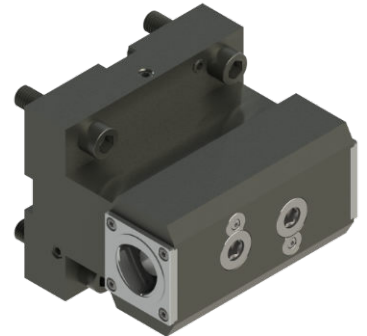

## ID Y holder

Right or left Y-axis ID quick coupling C4 holder

Turret	Code
BMT60	C4.DUR/L.MS60A.Y

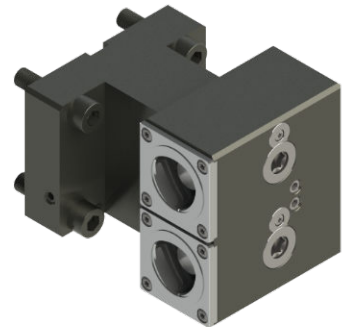

## ID X holder

Right or left X-axis ID quick coupling C4 holder

Turret	Code
BMT60	C4.DUR/L.MS60A.X



## ID double Y holder

Right or left double Y-axis OD quick coupling C4 holder

Turret	Code
BMT60	C4.DUR/L.MS60A.DY

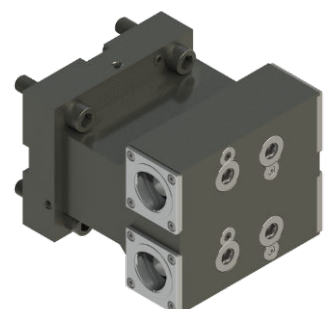

## OD driven holder

OD drilling or milling unit, C4 quick-coupling



Turret  
BMT60

Code  
C4.DPO.MS60A.E

## ID driven holder

ID drilling or milling unit, C4 quick-coupling

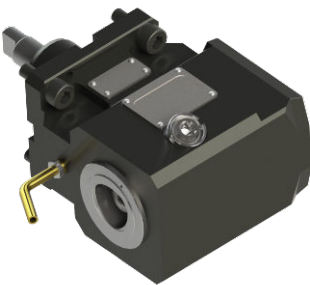

Turret  
BMT60

Code  
C4.DPF.MS60A.E

## ID cylindrical shank holder

ID holder for 40mm or 50mm cylindrical shanks

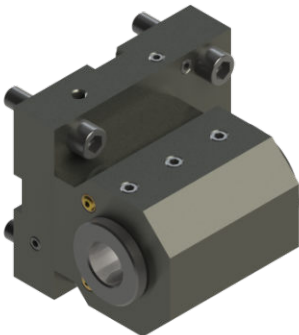

Turret  
BMT60  
BMT60

Code  
40.DU.MS60A  
50.DU.MS60A

## Cut off holder

Right, central, or left. A = 32mm

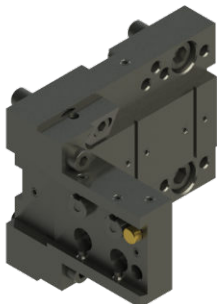

Turret  
BMT60

Code  
32C.DO.MS60A

## How to choose correct holder orientation - internal

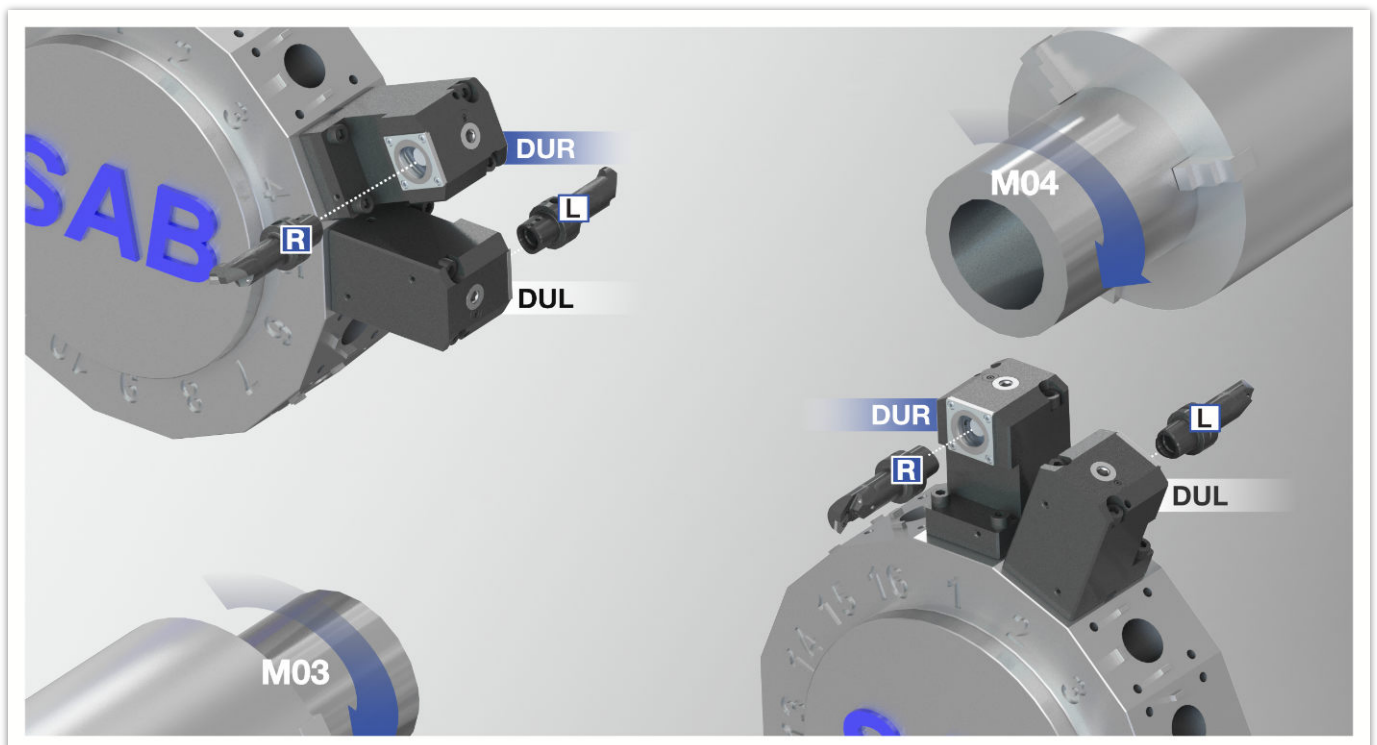
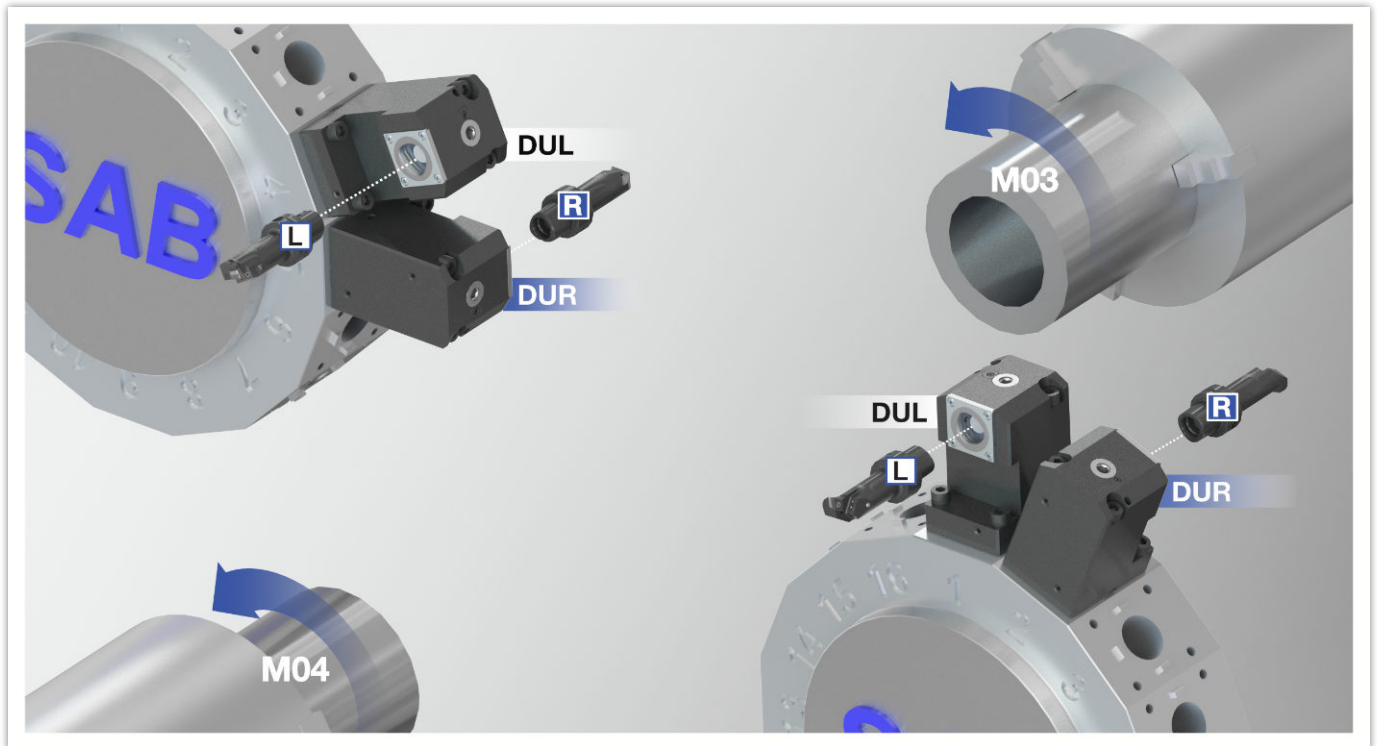

- |                             |                                   |                                 |
|-----------------------------|-----------------------------------|---------------------------------|
| <b>L</b> Left-hand adapter  | <b>DUL</b> Left-hand tool holder  | <b>M04</b> CCW spindle rotation |
| <b>R</b> Right-hand adapter | <b>DUR</b> Right-hand tool holder | <b>M03</b> CW spindle rotation  |



# How to choose correct holder orientation - external

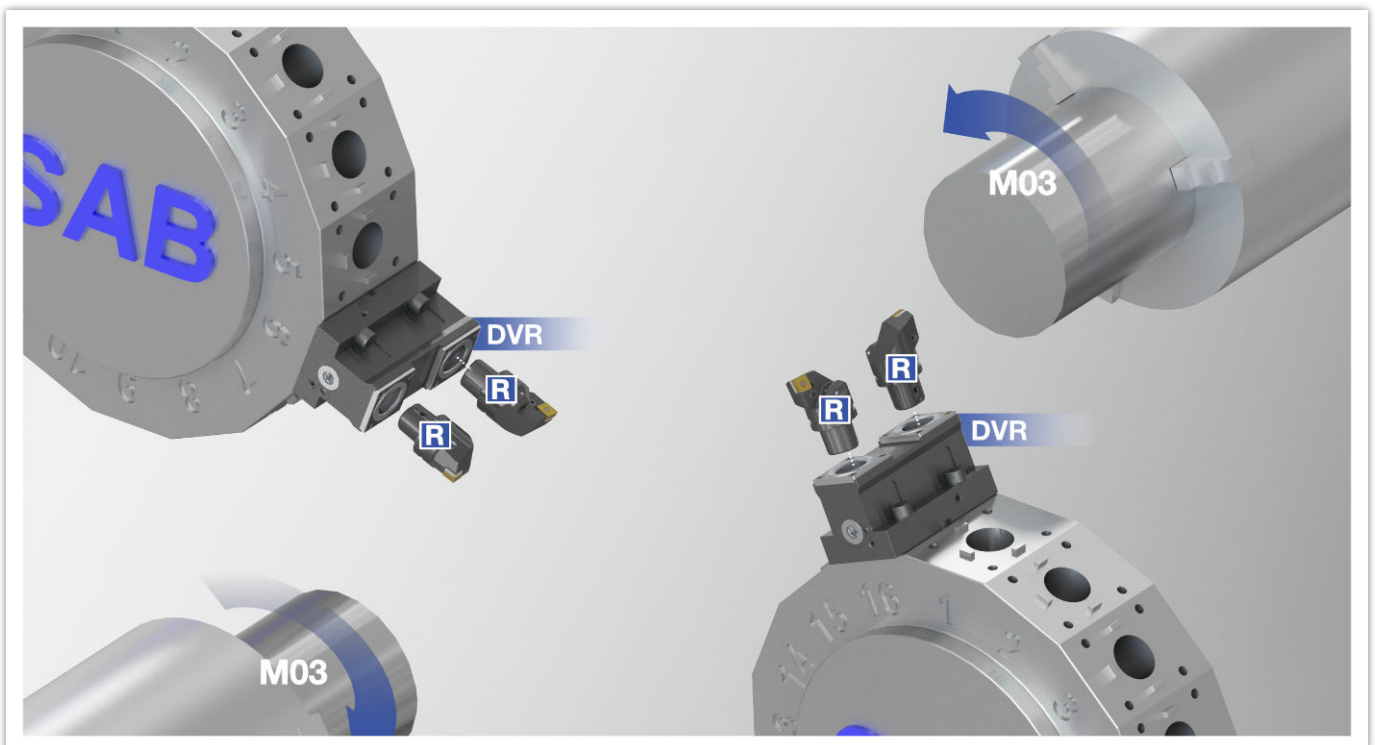
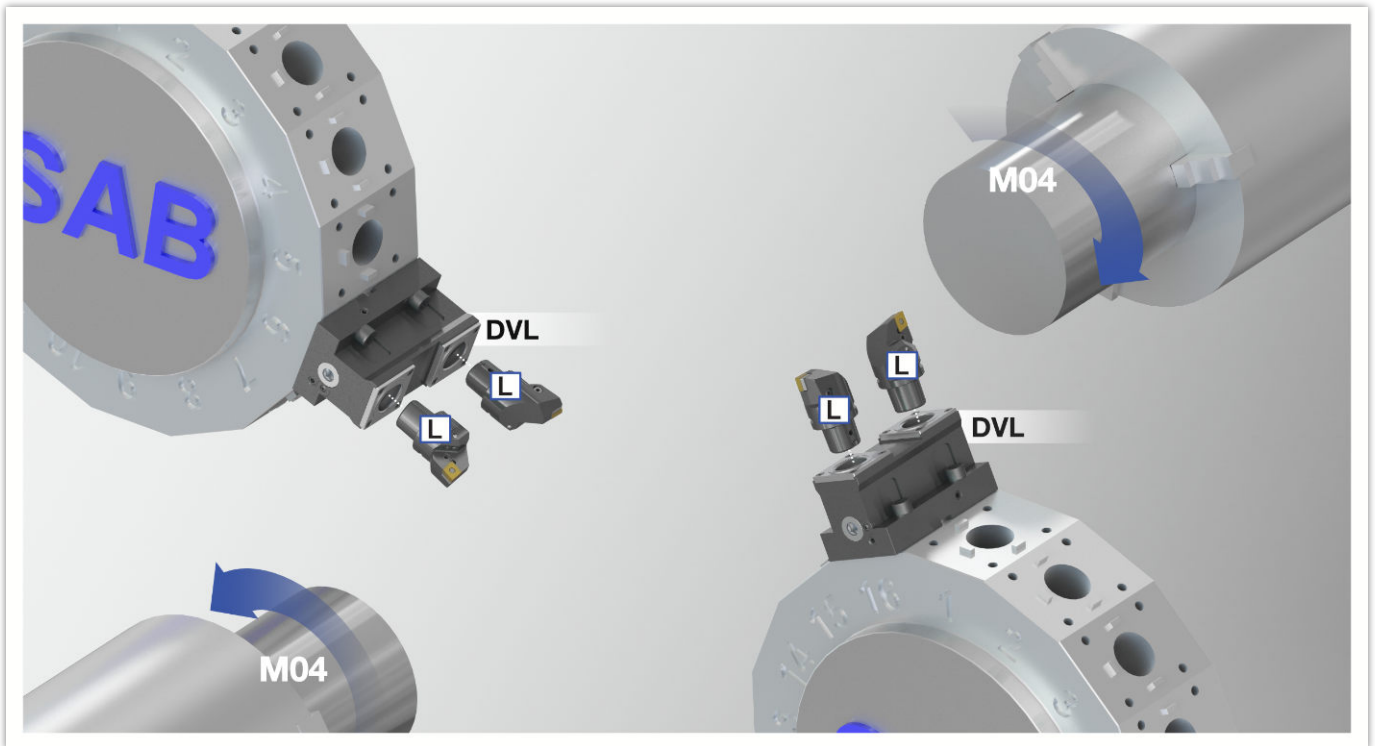

- L** Left-hand adapter      **DVL** Left-hand tool holder      **M04** CCW spindle rotation
- R** Right-hand adapter      **DVR** Right-hand tool holder      **M03** CW spindle rotation

## PSC adaptors for turning and milling

In order to provide complete solution for your machine, our turning and rotating PSC product line offers you wide range of tool holders for any application.

- 3 different sizes for turning - C4, C5 and C6
- ISO S, D and P clamping systems
- Standard rotating tool holders - Shrink fit chucks, end mill holders, shell mill holders, collet chucks
- Short adaptors - tool holders without gripper groove for ATC
- Rectangular shank adaptors - radial, axial, and angled
- Boring bar and indexable drills tool holders



**More information at [www.sab.hr](http://www.sab.hr)**



Find additional information  
and product catalogues

SAB d.o.o.  
Podborska 1b / 43500 Daruvar  
tel. + 385 43 675 850  
fax. + 385 43 334 700  
[sab@sab.hr](mailto:sab@sab.hr) / [www.sab.hr](http://www.sab.hr)